

# **peterson**

## **VS-II™**

### **Programmable Virtual Strobe Tuner**



## **Instruction Manual**

Revised May 2003

© 2003 Peterson Electro-Musical Products, Inc.  
11601 S. Mayfield Avenue, Alsip IL 60803-2476  
Phone: 1-708-388-3311 FAX: 1-708-388-3341  
[info@petersontuners.com](mailto:info@petersontuners.com)  
<http://www.PetersonTuners.com>



# TABLE OF CONTENTS

<b>The "Nickel Tour"—Getting Started <i>FAST!</i> . . . . .</b>	<b>4</b>
The Strobe Mode . . . . .	5
Line-Out Audio Mode . . . . .	5
The Light Mode (screen backlight). . . . .	6
Battery and AC Power Considerations . . . . .	7
Turning It ON . . . . .	7
<b>MODE Button and Special Functions . . . . .</b>	<b>8</b>
<b>MENU ITEM Parameters . . . . .</b>	<b>9</b>
Strobe Menu Items . . . . .	11
Line-Out Audio Menu Items . . . . .	12
Backlight Menu Items . . . . .	12
<b>RUN Screens In More Depth—Status Displays . . . . .</b>	<b>12</b>
<b>Tuning With The Virtual Strobe . . . . .</b>	<b>14</b>
Basic . . . . .	14
Tuning At Higher Octaves—Special Considerations . . . . .	14
Manual Note Selection . . . . .	16
<b>KEY Transposition—Explanation And Usage . . . . .</b>	<b>16</b>
<b>Temperaments and EDITing Programmable Temperaments. . . . .</b>	<b>17</b>
<b>Saving MENU Values As New Power-Up Defaults . . . . .</b>	<b>18</b>
<b>APPENDIX A —Temperament Settings . . . . .</b>	<b>21</b>
<b>APPENDIX B —Setting Guitar/Bass Intonation . . . . .</b>	<b>23</b>
<b>TROUBLE-SHOOTING HINTS . . . . .</b>	<b>25</b>
<b>TECHNICAL SPECIFICATIONS . . . . .</b>	<b>26</b>
<b>WARRANTY . . . . .</b>	<b>26</b>

# VS-II™ Programmable Virtual Strobe Instruction Manual

Congratulations on your purchase of the finest musical tuning device ever made—expanding upon **peterson's** visionary (patent pending) Virtual Strobe Technology™ to include new modern instrument preset and programmable-note tempering, "Passive Clean Bypass" audio chaining, and a sunlight-readable display!

## The "Nickel Tour"—Getting Started *FAST!*

How do you work this thing in a nutshell? Referring to the diagram below, the MODE button allows convenient access to the main operations: strobe tuning, line-out audio signal generation, and display backlight control. Menu items under each mode give complete control over all useful parameters.

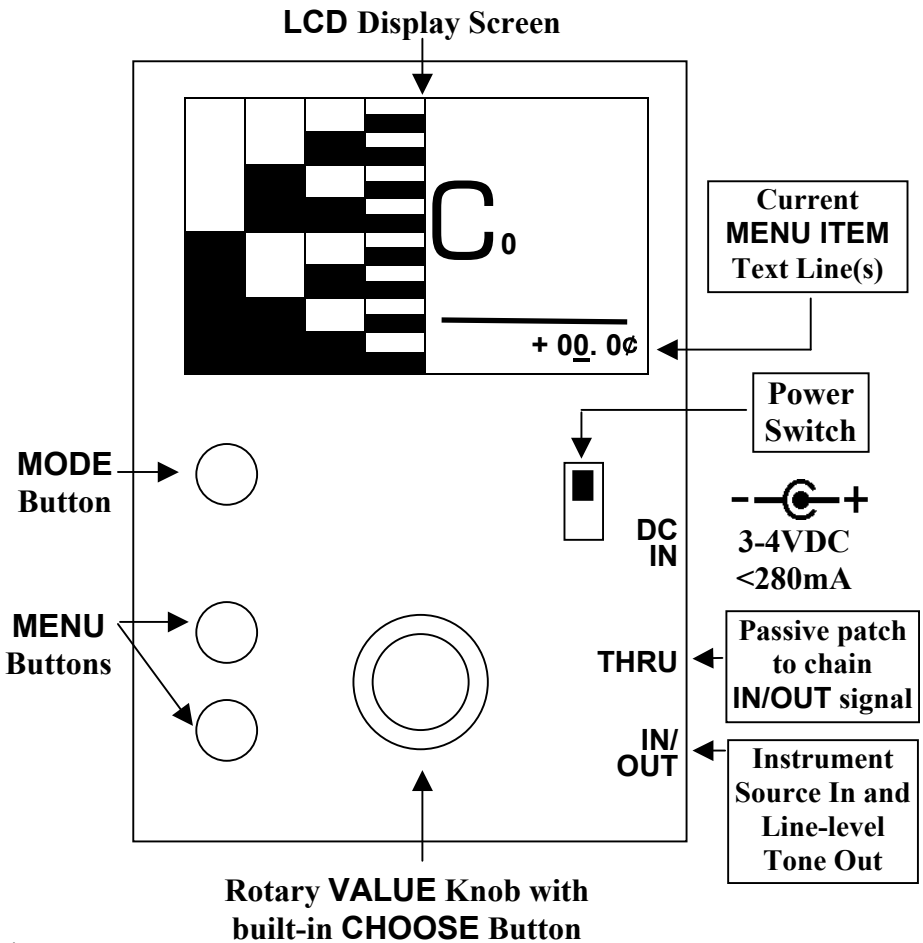

## The Strobe Mode

To tune with the strobe (refer to the diagram above):

- If using an electrified instrument (or pick-up like **peterson's** TP-1), insert 1/4" plug into the lower (IN/OUT) jack; otherwise position acoustic instrument within about 2 feet from the front face of unit.
- Slide Power Switch to ON. If tuning lower than three Cs below Middle C (e.g., 5-string electric bass, extended double bass, tuba, etc), press and hold lower MENU button (  ) while turning unit ON for **Bass Shift**.
- Use steady mouth pressure for winds; medium-intensity finger pluck (or bow pressure) away from bridge for string (with other strings *damped!*); medium-loud roll of mallet(s) or finger strike of keyboard; and use medium-loud volume settings for electrified instruments.
- Alter tuning control of instrument while viewing the strobe pattern and large Note Name display. If the scale-note name is not correct, please see the "**TROUBLE-SHOOTING HINTS**" section at the end of this manual.
- Flatten instrument pitch if strobe pattern is generally rolling upward (because the strobe is indicating that the pitch is sharp). Sharpen if rolling downward. (**NOTE:** for instruments with decaying loudness, the pattern will resume random appearance generally *BEFORE* the tone becomes inaudible! You then must regenerate the tone.)
- When pattern is steady or hovering about a fixed position, tuning is perfect!

To first see a reading of how far an instrument is out of tune (in cents), sound a tone and rotate the VALUE knob while  (cents) is the current MENU ITEM. (This "tunes" the VS-II to your instrument.) When the strobe pattern is steady or hovering about a fixed position, the display indicates the offset of the instrument from a standard note pitch (in cents) just above the horizontal line at the right side of the screen. (Press and hold the CHOOSE button on the VALUE knob until the cents value returns to zero before continuing with other tuning tasks.)

See "**APPENDIX B—Setting Guitar/Bass Intonation**" of this manual for details on setting string length for optimum instrument performance.

To use the other operational modes of the VS-II, press the MODE button.

### The Line-Out Audio Mode:

- Press the MODE button until the Audio Wave screen is displayed:

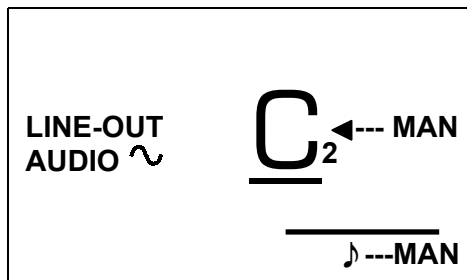

- After a brief delay, a line-level electrical signal tone will appear at the IN/OUT jack but only when the THRU jack is empty (to avoid accidentally feeding the loud tone through to a PA system previously connected at the THRU jack). The signal pitch will be at whatever scale note and offsets were last registered as indicated on the screen.
- Line-Out Audio mode begins immediately with the **MAN**ual note selection MENU ITEM. Spinning the VALUE knob at this point will then increment or decrement both the display and tone signal output by scale note through all octaves (indicated by the number just after the large scale-note display).
- The tone signal can be fine-tuned in any number of ways using the same menu items as appear in the Strobe mode: cents (one "MENU  $\Delta$ " button push from the above screen), A440 reference, temperament offsets, and so on.

## The Light Mode (screen backlight):

Press the **MODE** button until the following screen appears:

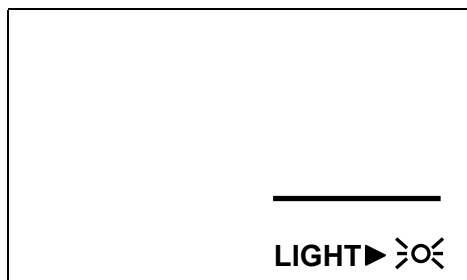

Rotating the **VALUE** knob or pushing the **CHOOSE** button will alter the backlight between  $\triangleright\triangleleft$  (on) and  $\bullet$  (dim). (The "dim" setting cuts battery drain by ~40%.)

For each of the 3 modes described above, the effect of changing settings for menu items is always immediate. Except for **AUTO/MAN**ual note selection, these changes will remain even if you cycle from one **MODE** to another. However, in order for any setting changes to persist after the unit is turned off, you must complete a **SAVE** operation (described in detail in a later section of this manual) for

each MODE whose settings you want to save. The SAVE screens appear as MENU ITEM screens, one under each MODE.

## Battery and AC Power Considerations

Your VS-II unit may be powered from either 3 AA-cell batteries or a *regulated* DC voltage from an AC wall transformer. Depending upon your location, an appropriate wall transformer may have been provided with the purchase of your VS-II. In any case, the wall transformer should provide a 3.0V to 4.0V *regulated* DC voltage from the AC line voltage *you are using* and accommodate at least 180mA of current (500mW of power). The DC IN jack requires a standard 2.1mm / 5.5mm plug with the positive (+) terminal as the inner plug:



**DO NOT USE A WALL TRANSFORMER WITH THE WRONG ORIENTATION OR VOLTAGE—PERMANENT DAMAGE MAY RESULT!!**

The batteries are automatically disconnected from the power circuit when a DC adapter plug is inserted into the DC IN jack. Any standard carbon or alkaline AA batteries may be used as a portable source of power. NiCad or NiMH rechargeable batteries may also be used but will *not* be recharged from this product! **Always use identical types of cells at any one time.** Battery life will vary greatly depending upon the type of battery used, the amount of product use with the LCD backlight or audio tone turned on, and the length of continuous use at each session. One fully charged set of low-capacity NiCad batteries may power the unit with intermittent use and backlight always on for 5-6 hours. A new set of (non-rechargeable) alkaline batteries used intermittently with backlight always off may last as long as 45 hours! Expect battery life to generally fall between these extremes.

It is recommended that batteries be removed if the product will not be powered with them for more than 1 month to avoid undetected corrosion or other battery failures. Batteries are inserted or removed by first removing the VS-II from its protective rubber boot. The Battery Cover at the back of the VS-II enclosure slides down and out with simple finger pressure.

**BE CAREFUL TO INSTALL BATTERIES IN THE INDICATED ORIENTATIONS—OTHERWISE, PERMANENT DAMAGE MAY RESULT!**

## Turning It ON

To turn the VS-II on, a convenient slide switch has been mounted on the face of the unit. **NOTE:** If either MENU button ( ▽ or ▲ ) is pressed during power-up, special operational modes—**Bass Shift** or **Temperament Edit**—will be activated. (These operations are described below.) Except for the **Temperament Edit** case, after a brief appearance of an initialization screen showing product identification and copyright, a strobe "RUN" screen will appear:

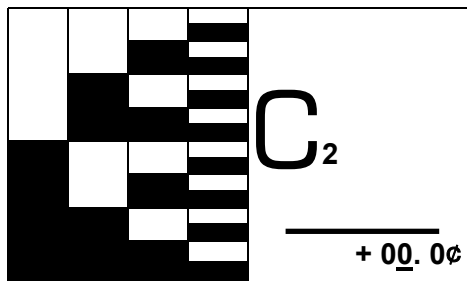



This first RUN screen always includes a four-band strobe display at the left, a large scale-note and octave indication (which may appear to fluctuate randomly when no clear input signal is present due to automatic note detection) and a current MENU ITEM of “cents” in the bottom text line under the horizontal rule (separation line). **This bottom line of text is *always* reserved for the indication of the current MENU ITEM or parameter—selected by either of the MENU buttons—which will currently be affected by the rotary VALUE knob and CHOOSE button.**

The VS-II will respond to any electrical signal (approximately  $\pm 10\text{mV}$  to  $5\text{V}$ ) presented to the IN/OUT 1/4" jack on the side of the enclosure including hand-held microphones, electric guitars, or line-level audio sources. The built-in microphone will be automatically activated for response to direct sound whenever the IN/OUT jack is empty. Generally, visual tuning is very simple. When the note indicator is at the nearest scale note to the sound source to be tuned, the strobe bands will appear to roll upward smoothly if the sound is sharp or down if it is flat. When the image appears stationary (or hovers around a fixed position), tuning is exact. The greater the apparent speed of movement in one direction, the farther the source pitch is from the reference scale note. (See the "**Tuning With The Virtual Strobe**" section below for more details and special cases.)

## MODE Button and Special Functions

The VS-II can be operated in any of three main modes selected at any time (after normal power-up) with the MODE button:

-  **Visual Tuning:** strobe display
-  **Audio Tuning:** mono line-out tone signal to the IN/OUT 1/4" jack
-  **Backlight Control:** bright or dim (battery saving)

Control over useful settings (menu items) for each of these modes is accomplished by first selecting the menu item of interest with either of the two MENU buttons until the item appears at the MENU ITEM section at the lower right side of the display. (These two buttons move in opposite directions through a mode's list of menu items for your convenience.) Then the selected menu item may be altered



simply by spinning the VALUE knob at the center of the unit (or, in some cases, "choosing" alternatives for the menu item with the CHOOSE button built into the VALUE knob). Most menu item values can be *saved* as power-up defaults under SAVE which is one of the choices in the menu item list for each mode. You will save over only those menu item settings that appear on the right side of the display when SAVE is the current MENU ITEM.

There are two special functions on the VS-II which can be entered only at the time you power the unit on. **Bass Shift** lowers the range of notes available for tuning by 2 octaves in the Strobe and Line-Out Audio modes and is initiated by depressing the *lower* MENU button (also marked as ♯: ) while turning the VS-II on. The **EDIT** power-up function allows access to enter and save values into two 12-note programmable temperament files and is initiated by depressing the *upper* MENU button (also marked as EDIT) while turning the VS-II on. **NOTE: NO other operational modes are accessible once EDIT has been selected at power-up!** Once initiated, the **EDIT** or **Bass Shift** functions remain in effect until the VS-II unit is turned off.

## MENU ITEM Parameters

The two circular buttons at the bottom left of the VS-II (labeled MENU with "▲" and "▼" arrows) allow the selection of various useful parameters under each mode of device operation. Because certain combinations of parameters will be changed frequently in some applications, the pair of MENU buttons allows the user to a) quickly alternate between any two adjacent menu items and b) reduce the number of required button presses to scroll from one menu item to any other.

**EXAMPLE:** Altering the TMPR (temperament) setting

First of all, note that menu items and their settings are *COMMON* between Strobe mode and Line-Out Audio mode. A change made to a menu item like TMPR (temperament) under Strobe mode will also appear when viewing TMPR under Line-Out Audio mode. (The one exception to this is AUTO/MANual note detection which is always forced to MANual under Line-Out Audio mode and forced to AUTO when switching back to Strobe mode.) Let us assume that we are currently under Strobe mode operation. To change the temperament setting, press either of the two MENU buttons until "TMPR:" appears on the MENU ITEM line of the display:

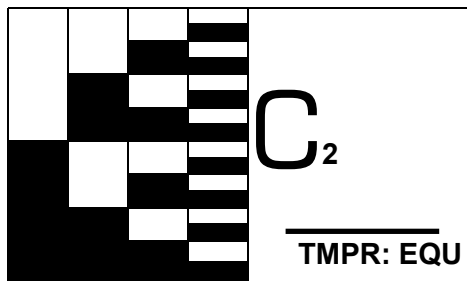

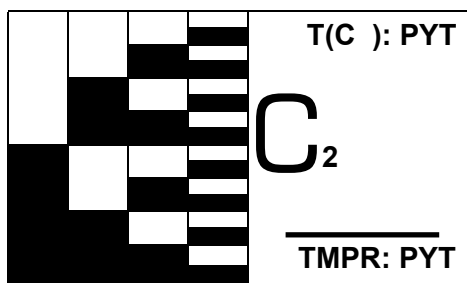

The 3-letter acronym after this indicates the current setting for temperament. **NOTE:** if not "EQU" (the default setting), the non-default status will also appear at the upper right portion of the display. In the VS-II, the TMPR settings are predefined with note C as the root or home key. This is also indicated in the status line for TMPR when a non-default value is selected. (See the "**RUN Screens In More Depth—Status Displays**" section below for more on status displays.)

Now that TMPR is the current MENU ITEM, the setting is changed simply and immediately by dialing in a new temperament with the VALUE knob. (For further information about temperaments and their use, see "**Appendix A**" of this manual.) From the screen shown above, the following screen appears after dialing the VALUE knob by one detent in the clockwise direction:



The following table describes the effect and range of each MENU ITEM under Strobe mode in order from ♢ ("cents") at power-up to ♮ (note selection) that the user would see by repeatedly pressing the  $\Delta$  arrow MENU button. Also shown is the effect, if any, of pressing the CHOOSE button built into the VALUE rotary knob:

MENU ITEM	DESCRIPTION	↶ ↷ VALUE RANGE / <u>DEFAULT</u> VALUE	CHOOSE ▽ BUTTON
¢ (cents)	1 cent = 1/100 semitone offset ( $^{1200}\sqrt{2}$ )	-50.0 to +50.0 / <u>00.0¢</u>	1¢ / 0.1¢ steps Hold: 0 reset
KEY	Transposition of the <i>displayed</i> note based on any of 12 scale notes	B♭ to A / <u>C</u> -2 to +9 / <u>+0</u>	Letter / Fret # scale
A4	Concert A tuning reference adjustment for the tuner in 0.5 Hz increments	433.0 to 447.0 / <u>440.0</u>	—
TMPR	EQUAL or one of 13 non-equal temperaments (note-to-note intervals) with root note C set to 0 ¢ offset (for historical TMPRs)	<u>EQU</u> Equal; root= <u>C</u> <u>PYT</u> Pythagorean <u>JST</u> Just Major <u>MNT</u> 1/4 Meantone <u>KRN</u> Kirnberger <u>WRK</u> Werkmeister <u>YNG</u> Young <u>KLN</u> Kellner <u>GTR</u> Guitar <u>BAS</u> Bass Guitar <u>SE9</u> Pedal "E" neck <u>SC6</u> Pedal "C" neck <u>P-1</u> Programmable1 <u>P-2</u> Programmable2	—
SAVE	Store MENU ITEM values in memory as new power-up values	TMPR } SURE ?? A4 } Confirm KEY }	1 <sup>st</sup> : SURE ?? 2 <sup>nd</sup> : SAVED ✓
	Note selection	C <sub>1</sub> to G <sub>8</sub> :  / <u>AUTO</u> C <sub>-1</sub> to B <sub>6</sub> : " Bass Shift*	AUTO / MAN

\*By pressing the bottom (  : ) MENU button during power-up, the resulting **Bass Shift** (shown by a bass clef near the octave number) permits visual tuning down to C<sub>0</sub> and beyond (~8Hz). This is especially useful when tuning instruments with extended bass range: 5-string electric bass, extended double bass, tuba, and so on.

Line-Out Audio mode menu items are the same as under Strobe mode except the first MENU ITEM is note selection:

MENU ITEM	DESCRIPTION	VALUE RANGE / <u>DEFAULT</u> VALUE	CHOOSE ▾ BUTTON
♪	Manual note selection	C <sub>0</sub> to B <sub>8</sub> : Audio / <u>C</u> <sub>2</sub> C <sub>-2</sub> to B <sub>6</sub> : Bass Shift / <u>C</u> <sub>0</sub>	—

**NOTE:** Automatic note selection is *NOT* possible in this mode of operation. If the ♪ (note selection) menu item is made current under Line-Out Audio mode, the usual “select arrow” in the MENU ITEM line is replaced to indicate that AUTO cannot be selected with the CHOOSE button. In other words, notes must be *manually* selected when in the Line-Out Audio mode:

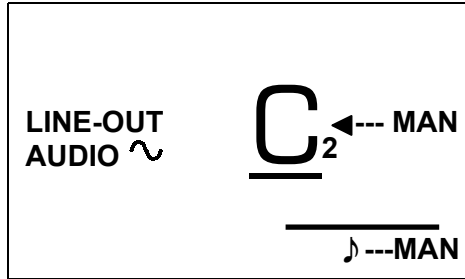

When switching from Line-Out Audio mode to Strobe (visual) mode, the strobe bands are once again made visible and the note selection is forced to AUTO.

Finally, the Backlight Control mode includes only two MENU ITEMS:

MENU ITEM	DESCRIPTION	VALUE RANGE / <u>DEFAULT</u> VALUE	CHOOSE ▾ BUTTON
LIGHT	LCD backlight full ON or dim	☀️ ON    ● OFF (dim)	<u>ON</u> / OFF
SAVE	Store MENU ITEM value in memory as new power-up value	LIGHT } SURE ?? Confirm	1 <sup>st</sup> : SURE ?? 2 <sup>nd</sup> : SAVED ✓

## RUN Screens In More Depth—Status Displays

Each mode's RUN screen may include additional indications at the top right of the display if one or more MENU ITEM values for that mode have been set or saved to non-factory-default values in any previous operation of the unit. The *savable* MENU ITEM values under Strobe and Line-Out Audio modes are:

SAVABLE MENU ITEMS	DESCRIPTION	DEFAULT VALUE
TMPR	EQUAL or non-equal temperaments with root (home key) of C	EQU
A4	Concert A tuning reference	440.0
KEY	Transposition of the displayed note	C

To simplify the appearance of the display screen, the additional “status display” of TMPR, A4, or KEY is made visible *ONLY* when a non-default value for the given MENU ITEM has been selected. Once altered to a non-default value, a “status display” for an item will appear immediately whether the new value is saved or not.

As noted in the previous section of these instructions, an additional status display indicating MANUAL note selection (which is *NOT* a “savable” MENU ITEM) is made visible when active as a reminder that the note selection and indicator will *NOT* change to the nearest note detected in the incoming audio signal as it would with AUTO note selection (which is always the power-up default).

Thus, for example, if TMPR (with root predefined at note C) had been previously saved to JST (Just Major temperament), A4 had been saved to 440.0 (the default), KEY had been saved to F, and the VS-II had last been set to MANUAL note selection, the LCD display screen might look like this:

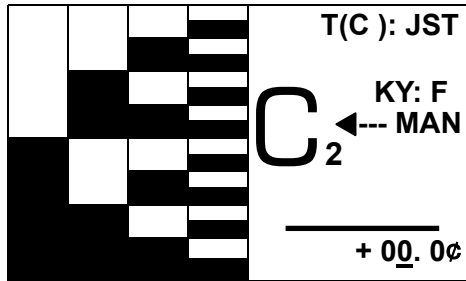

If the A4 menu item is then changed to a non-default value (even if it is not saved) by pressing one of the MENU buttons to make A4 the “current MENU ITEM” in the bottom text line and turning the VALUE rotary knob to display a value of, say, 440.5, then the non-default status of A4 will appear in its given position (second text line). These non-default status displays will remain even when a new current MENU ITEM (¢, for example) is selected:

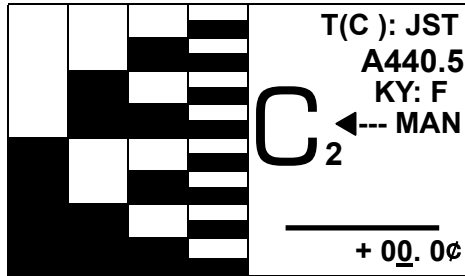

## Tuning With The Virtual Strobe

The simplest and most commonly used VS-II operation will be visual tuning with AUTO note detection/selection. This is accomplished through the following grueling sequence of steps:

- Turn the VS-II ON.

Yes, that’s it! The VS-II always powers up in Visual (strobe) tuning mode with AUTO note selection. Unlike traditional strobe devices, the VS-II will *not* respond to harmonics or high-frequency “partials” of an incoming sound. The four strobe bands are provided only to extend the useful visual response to more octaves of musical pitch. Generally, the “lowest” band that is visible (a leftmost, larger-striped band corresponding to one of the lower OCTAVE number ranges listed beneath) is the most accurate band to “read”.

### Tuning At Higher Octaves—Special Considerations

At higher pitches (from Octave 4 and up), the lower bands do not convey useful indications of tuning. If shown, they would appear to move randomly while the higher bands show true relative tuning motion for the incoming sound. To avoid unnecessary distraction, these lower bands are successively “blacked out” when higher octave pitches are detected. For example, if one hums an A440 pitch and it is AUTO-detected by the VS-II, the screen will change to the following:

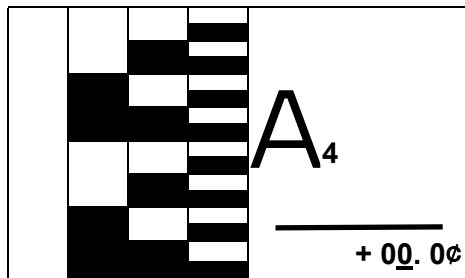

If 880Hz (A5) is sounded and detected:



If a low pitch is then sounded (octaves 1 to 3), all four strobe bands will return.

There is another nuance of visual tuning with the VS-II when reading tunings for high octave sounds. Normally, AUTO note selection will adjust the tuner to the scale-note frequency nearest to that of the incoming sound. Usually, this means that the incoming sound can vary by  $\pm 50\text{¢}$  ( $\pm 1/2$  semitone) before the reference scale-note indication is adjusted. As the incoming sound goes flatter (lower frequency) compared to the AUTO-note frequency, the strobe image will appear to move downward at an increasing rate. Conversely, as the incoming sound goes sharper relative to the scale note, the image appears to move upward at an increasing rate.

Normally, this movement is easy to see over the entire  $\pm 50\text{¢}$  range. However, for notes at higher octaves, the rate of movement when approaching the 50¢ offset extremes becomes difficult to see with the eye. (It's not unlike the effect of "seeing" hubcap spokes on a moving car *apparently* turning backwards from their actual motion in a movie film.) In these cases, the VS-II produces either an appropriate  $\sharp\sharp$  or  $\flat\flat$  symbol in place of strobe bands. The pitch range over which the strobe bands remain for visual tuning gets narrower at higher frequencies, but even at Octave 8, the strobe bands will be available for fine-tuning to match the scale note. Think of the alternate  $\sharp\sharp$  and  $\flat\flat$  indicators as quick and easy-to-read "way out of tune" signals. Below is an example of the display screen when a sound that is 30¢ sharp of A5 is detected by the tuner:

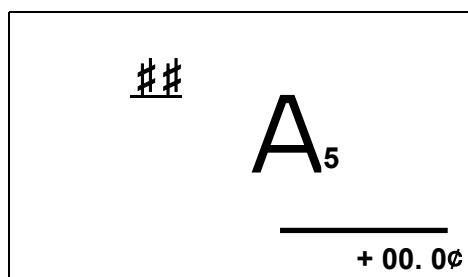

## Manual Note Selection

When tuning under unusual circumstances—tuning extremely high-pitched notes or low volume sounds in noisy environments—it may be necessary to manually select the note to which you would like to tune. Press one of the MENU buttons until  $\text{♩}$  (note selection) becomes the current MENU ITEM. At this point, pressing the CHOOSE button (built into the VALUE knob) will select between AUTO and MAN note selection methods. Alternatively, you can simply rotate the VALUE knob to select the desired note (and octave) which, in turn, forces the VS-II into MANual note selection.

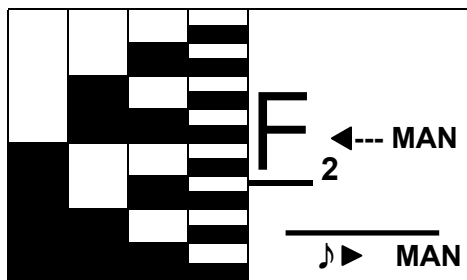

## KEY Transposition—Explanation And Usage

The KEY menu item provides a simple means of transposing note names for instruments built around something other than Concert C pitch (for example, a  $B\flat$  clarinet or  $E\flat$  saxophone). In addition, with the VS-II, **peterson** includes its exclusive Fret Transposition Scale (FTS) which provides a clearer, more meaningful transposing system for fretted instruments than the standard alphabetical note name keys.

For example, when a guitar is in its standard tuning, we commonly call the open-string notes: E, A, D, G, B, and E. These are the Concert C key signature note names for those sound frequencies. However, guitarists commonly think of this tuning as standard E tuning because of the preponderance of Key of E notes. Obviously, this can get confusing. Our Fret Transposition Scale (accessed by pressing the CHOOSE button while the current MENU ITEM is KEY):

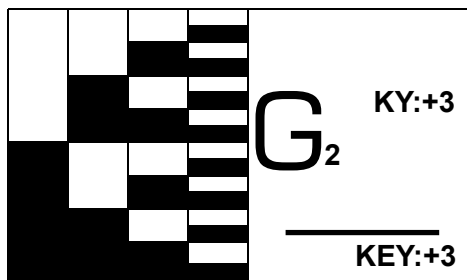



provides an optional numbering system for key transposition which corresponds to the equivalent fret “stop” of the strings. For example, if you apply a capo (on a standard-tuned guitar) on the 3<sup>rd</sup> fret, the new “open string” notes without key transposition would be: G, C, F, A#, D, and G. If you would like to tune these new “open string” notes without having to mentally transpose note names, you would simply select an FTS key value of “+3” which corresponds to the 3<sup>rd</sup> fret in this example. In this case, the “open string” notes will once again be displayed as E, A, D, G, B, and E on the screen.

To carry the analogy further, the open strings without a capo (the normal case of the nut stopping the strings) is equivalent to the 0<sup>th</sup> fret and so “+0” under FTS yields the standard note names for the open strings. Further, if you detune the strings *down* as in “½-step drop” (or “flat”) tuning, this would be equivalent to having an “extra fret” as the stop in the opposite direction. Hence, the FTS key to use would be “-1”. Our FTS system, in fact, permits transposition from -2 to +9 which corresponds to B $\flat$  to A in standard key transposition.

One more subtlety: for advanced users employing non-equal temperaments (under the TMPR menu item), key transposition still affects *only* the note *names* for use with non-Concert C instruments. **The tonic or root frequency of the temperament remains at Concert C pitch.**

## Temperaments and EDITing Programmable Temperaments

"Temperament" refers to adjustments of note-to-note tuning intervals in a scale to produce various effects (reduced "beating", key "color") and is explained more fully in "**Appendix A**" of this manual.

Programmable temperaments are activated in the VS-II just as any preset temperament is, and they appear in the temperament list as P-1 and P-2. To actually view, change, or save programmable temperament offsets, however, the special **EDIT** mode must be activated by holding the EDIT button while turning the VS-II on (as explained in the "**MODE Button and Special Functions**" section of this manual).

In **EDIT** mode, only the EDIT button, VALUE knob, and CHOOSE button (built into the VALUE knob) are active. The EDIT button scrolls and loops through 3 choices:

- Edit P-1 temperament file
- Edit P-2 temperament file
- Access **SAVE** screen for *BOTH* temperament files

The VALUE knob scrolls through cent offset settings for the currently displayed scale note and temperament file. The CHOOSE button advances the scale note to be programmed for the currently selected temperament file. The screen below

shows an **EDIT** screen which will currently allow the C# scale-note offset of the P-2 temperament file to be altered (by the VALUE knob), the C# scale note of the P-2 file to be advanced to D (by the CHOOSE button), or the **EDIT** screen to be advanced to the **SAVE** temperaments screen (by the EDIT button):

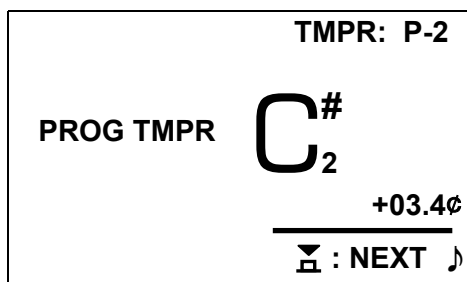

Under the **EDIT SAVE** screen, a first push of the CHOOSE button calls a **SURE ??** confirmation screen. A second push of the CHOOSE button will actually save—after a short delay—all the scale note presets entered (or left unchanged) for *BOTH* the P-1 and P-2 temperament files. The **SAVE** function can be aborted by pushing the **EDIT** button or dialing the **VALUE** knob one position instead of pushing **CHOOSE** again during the **SURE ??** confirmation screen.

**NOTE:** since the VS-II must be turned off after editing temperaments, it is important to *ALWAYS SAVE* your programmed offsets *before* exiting **EDIT** mode!

## Saving MENU Values As New Power-Up Defaults

Your VS-II unit is initialized at the factory with **MENU ITEM** values that are generally considered to be standard and will not need to be changed by a great many users. Under the Strobe and Line-Out Audio modes, these are:

- **EQU**al Temperament
- **Concert A** at 440.0Hz
- **KEY** transposition at **C** (standard “concert” pitch)

**NOTE:** the above settings are *COMMON* to the two tuning modes! In other words, changing the **Concert A** reference under one mode, for example, will change the value under the other mode.

The default LCD backlight setting is **ON** (bright).

These values can be changed at any time when in the appropriate operational mode (as can all other **MENU ITEM** values except attempting to choose **AUTO** note selection when Line-Out Audio mode is activated). The values of the above menu items may be changed *and saved* by the user as new power-up defaults.

Before entering the SAVE sequence, the values of *all* of the savable menu items under the current MODE should be at the desired settings. For this example, let us assume that under the Strobe mode:

- Tmpr is JST (Just Major)
- A4 is 435.5 Hz
- KEY is B b

Press either the “ $\triangle$ ” or “ $\nabla$ ” MENU buttons until SAVE becomes the current MENU ITEM:

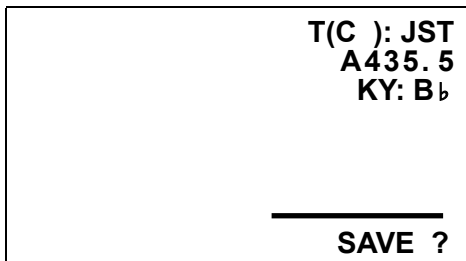

At this point, the current values of the savable menu items are displayed so that you can review the values you will be saving. Pressing either MENU button at this point will cause a new MENU ITEM to become current and no saving operation will have occurred. By either turning the VALUE knob or pressing the CHOOSE button once, however, a “confirmation” screen will appear:

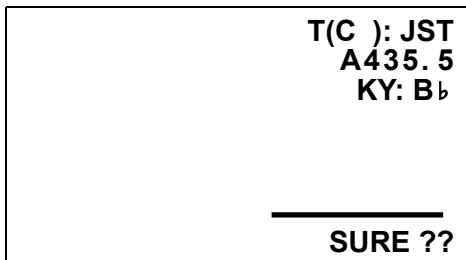

The question “SURE ??” now appears on the current MENU ITEM line. Once again, pressing either MENU button will cause a new current MENU ITEM to appear and the SAVE procedure will have been aborted with *no* change to the saved values. Similarly, turning the VALUE knob by one “click” will step back to the first “SAVE ?” screen. However, if the CHOOSE button is pressed while the “confirmation” screen is active, the SAVE procedure will have been completed as indicated by the final screen:

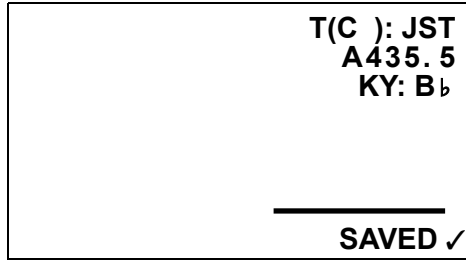

The VS-II unit would now power-up with these MENU ITEM values until a new SAVE procedure is completed. The last entered VS-II mode will resume when one of the MENU buttons is pressed to activate a new “current MENU ITEM” and exit the SAVE screen. Saving MENU ITEM values under the Strobe, Line-Out Audio, and Light modes works in identical fashion.

## APPENDIX A —Temperament Settings

Lately, the word "temperament" has entered the language of many musicians (notably guitarists and bassists) who never before had a term that could describe the tuning shortcomings of their instruments. Many modern instruments are constructed assuming "equal tempered" scale-note intervals. This is simply one of an infinite number of ways to tune one scale note relative to another, and it can create serious tuning shortcomings. However, by taking advantage of the distinct characteristics of certain instruments (guitar, bass, steel guitar) or prevalent key signatures (for the remaining "historical temperaments" in the list), alternate temperaments are possible which generally "sweeten" the chords and intervals played on these instruments *without* compromising the overall tuning relative to other pitched instruments being played.

By nature of a temperament being "unequal", some chords and keys—generally, major and minor keys at (or diatonically related to) the root note on which the temperament is built—are "favored" while more remote keys have chords that sound *worse* than those of Equal Temperament. Historically, keyboard temperaments are rooted on note C; the VS-II follows this tradition. The modern and proprietary temperament presets in the VS-II are built in such a way that standard-tuned (or 1/2-step down) guitars and basses (GTR and BAS) as well as standard-tuned E and C necks (or universal neck) of a steel guitar (SE9 and SC6) can utilize them without modification. If other tunings or root notes are required for a particular application, the user can produce and save such custom temperaments in the P-1 and P-2 programmable temperament areas. (See the "**Temperaments and EDITing Programmable Temperaments**" section above.)

**EQU** (Equal) is "standard" modern tuning (that would appear in a typical keyboard synthesizer, for example).

**PYT** (Pythagorean) produces perfect 4<sup>th</sup>/5<sup>th</sup> intervals (except the bIII-bVI interval for a given root). It is quite useful for open string tuning of bowed instruments.

**JST** refers to "Just Major" and generally provides perfect beatless major 3<sup>rd</sup> and 4<sup>th</sup>/5<sup>th</sup> intervals in the root diatonic key. However, avoid using the II-major chord intervals for a given root (D-F#-A with root=C, for example). JUST tuning is especially useful for brass, woodwind, and vocals.

**MNT** (1/4 Comma Mean Tone) is a fairly flexible "compromise temperament" producing good results in all major/minor keys based on the diatonic notes from the chosen root (except VII major and IV minor). It is a popular "historic" tuning for piano, organ, and baroque keyboard instruments (harpsichord, clavichord, etc).

**KRN** (Kirnberger III) is a "well-tempered" historic temperament with strong "key color" differences, suitable for pipe organ and baroque keyboard instruments.

**WRK** (Werckmeister III) is similar to Kirnberger III above but with a greater range of useful key signatures for a given root (in exchange for increased beating among some intervals in "favored" keys). It is yet another option for historic tuning of piano, organ, and baroque keyboard instruments.

**YNG** (Young) is "well-tempered" with milder "key color" variations than the above historic temperaments (i.e., more similar to Equal temperament). It is yet another historic keyboard instrument temperament.

**KLN** (Kellner) is "well-tempered" with a pleasing variation in key color and also suitable for historic tuning of piano, organ, and baroque keyboard instruments.

**GTR** is a proprietary electric and acoustic guitar setting geared toward "sweetening" the 4<sup>th</sup> and 5<sup>th</sup> intervals on a standard-tuned or ½-step-flat guitar (and bass when played in combination with a GTR-tuned guitar). GTR improves other intervals as well. For best results, use the default EQU temperament for intonation (string length setting), then tune open strings using GTR. See "**APPENDIX B**" or [www.PetersonTuners.com/news/ttopics/index.cfm](http://www.PetersonTuners.com/news/ttopics/index.cfm) for more about guitar setup.

**BAS** is a proprietary bass setting useful for percussive playing and when playing along with a stretch-tuned keyboard (acoustic piano or other string or bar-struck keyboard). For best results, use the default EQU temperament for intonation (string length setting), then tune open strings using BAS.

**SE9** and **SC6** refer to "E9" tuning and "C6" tuning, respectively, for the two standard necks of a steel guitar. They supply "well-tempered" intervals to "sweeten" internal chords but are scaled around equal temperament so as to minimize tuning errors when playing along with "standard tuned" instruments. (Since these are 12-note files, "universal neck" is also accommodated.)

<b>E9 neck</b>	<b>B</b>	<b>D</b>	<b>E</b>	<b>F#</b>	<b>G#</b>	<b>B</b>	<b>E</b>	<b>G#</b>	<b>D#</b>	<b>F#</b>
<b>C6 neck</b>	<b>C</b>	<b>F</b>	<b>A</b>	<b>C</b>	<b>E</b>	<b>G</b>	<b>A</b>	<b>C</b>	<b>E</b>	<b>D/alt G</b>

Low High

### Temperament Presets—Offsets Chart

<b>TMP</b>	<b>C</b>	<b>C#</b>	<b>D</b>	<b>D#</b>	<b>E</b>	<b>F</b>	<b>F#</b>	<b>G</b>	<b>G#</b>	<b>A</b>	<b>A#</b>	<b>B</b>
EQU	+0.0	+0.0	+0.0	+0.0	+0.0	+0.0	+0.0	+0.0	+0.0	+0.0	+0.0	+0.0
PYT	+0.0	+13.7	+3.9	-5.9	+7.9	-1.9	+11.8	+2.0	+15.7	+5.9	-3.9	+9.8
JST	+0.0	-29.3	+4.0	+15.7	-13.6	-1.9	-31.2	+2.0	-27.3	-15.6	+17.6	-11.7
MNT	+0.0	-23.7	-6.8	+10.3	-13.7	+3.2	-20.1	-3.4	-27.4	-10.4	+7.2	-16.8
KRN	+0.0	-9.8	-7.8	-5.9	-13.7	-1.9	-9.7	-3.9	-7.8	-11.7	-3.9	-11.7
WRK	+0.0	-9.8	-6.9	-5.9	-8.3	-2.0	-11.8	-3.5	-7.9	-10.3	-4.0	-6.4
YNG	+0.0	-9.8	-3.8	-5.9	-7.6	-1.9	-11.9	-1.9	-7.8	-5.8	-3.9	-9.5
KLN	+0.0	-9.8	-5.5	-5.9	-10.9	-1.9	-11.7	-2.7	-7.8	-8.2	-3.9	-9.0
GTR	PROPRIETARY											
BAS	PROPRIETARY											
SE9*	-17.8	-5.9	+5.9	-3.9	+9.8	-17.8	+5.9	+5.9	-3.9	+3.9	+9.8	+7.9
SC6*	+9.8	-17.8	-5.9	+9.8	-3.9	+5.9	-13.8	+7.9	+9.8	-5.9	+0.0	-5.9
P-1												
P-2												

\*Values derived by integrating and expanding upon steel guitar tuning theory and data described by Buddy Emmons, Jeff Newman, and others from various sources.

## APPENDIX B —Setting Guitar/Bass Intonation

After deciding on string gauge, string height setting (nut and bridge), and neck relief—factors that affect guitar or bass intonation considerably—the individual string lengths must be adjusted.

- Lower the pickups away from the strings to avoid "doubling" and electromagnetic pull.
- Lay the instrument flat on a bench to adjust it, but always check the intonation with the instrument in the playing position as the readings will be visibly (and later *audibly*) different. You should always aim to freeze or "cage" the image of the VS-II strobe display; the less overall movement up or down, the more accurate the results.
- Always slacken the string while adjusting the saddle position. Failing to do so may damage the string, the saddle, or in some cases, even the neck!
- Apply some graphite to the nut slots. This helps prevent the string from binding.

As previously stated, "action" is another important factor influencing correct fretting (intonation). The higher the action, the further the string must be depressed to contact the fret. As this happens, greater pressure is exerted on the string resulting in an increase in pitch.

A high action may cause sharp notes; a low action may cause fret buzz. Action adjustments can be made at the nut, saddle, or in extreme cases, by resetting the neck. (On a banjo, coordinator rods or dowel sticks can be adjusted for proper action.)

A common method for setting intonation is to compare the 12<sup>th</sup> fret (pressed) and 12<sup>th</sup> fret flageolet (harmonic):

- If the fretted note is *flat* compared to the flageolet note, move the bridge saddle *forward* to shorten the string.
- If the fretted note is *sharp* compared to the flageolet note, move the bridge saddle *back* to lengthen the string.
- Adjust until both fretted note and flageolet are identical in pitch.

While this is a common technique, it is not always the most satisfactory. Another popular alternative is to adjust each string so that it is in tune at two points an octave apart from each other on the fretboard with a strobe tuner. Using the 5<sup>th</sup> and 17<sup>th</sup> fret as an example:

- Tune a string at the 5<sup>th</sup> fret.
- Check the string at the 17<sup>th</sup> fret. If sharp, move the saddle back to lengthen the string. If flat, shorten the string by moving the saddle forward. Remember to fret the string using the pressure that you would normally apply while playing!
- Repeat this process until each string is in tune as much as possible at both the 5<sup>th</sup> and 17<sup>th</sup> frets.

This method takes time and must be repeated if you change string gauges but, if properly executed, yields very satisfactory results.



Now, tune your guitar or bass using the default EQU temperament setting on the VS-II, or for added tuning quality, try the GTR or BAS settings (see "**APPENDIX A**" for more details.)

Please note that we have not referred to any method involving structural changes such as shortening the fretboard or relocating the nut. This is best discussed with a professional instrument technician.

The tuning/intonation methods are within anybody's reach. All you need are your ears and your **peterson** Strobe Tuner.



## TROUBLE-SHOOTING HINTS

IF:	IT COULD MEAN:
I cannot switch from <b>MAN</b> ual note detection to <b>AUTO</b> under the <b>♪</b> menu	If " <b>LINE-OUT AUDIO</b>  " appears on the left side of the display screen, the device is in the Line-Out Audio mode, which does not allow <b>AUTO</b> note detection. Either change the note manually (by turning the <b>VALUE</b> knob) or change the current <b>MODE</b> to strobe: 
Lower octave strobe band(s) appear random while upper ones seem to respond to input	Under <b>MAN</b> ual note detection: the selected octave is probably lower than the input signal octave. Under <b>AUTO</b> note: the analyzed octave is probably lower than that of the actual signal, often due to a weak (low-level) input.
In Strobe mode, the four strobe bands will not appear in the LCD screen	Either the <b>VS-II</b> is in a <b>SAVE</b> screen or the signal frequency is too distant from the reference note/octave (look for a <b>##</b> or <b>b b</b> symbol in place of the strobe band display). If in <b>MAN</b> ual note detection, check that the selected note is appropriate.
In Strobe mode, the indicated scale note does not match what I'm playing	First, verify that <b>AUTO</b> note detection is currently enabled (no <b>MAN</b> text to the right of the large scale note display). If not enabled, use a <b>MENU</b> button to change the current <b>MENU ITEM</b> to " <b>♪</b> " and press the <b>CHOOSE</b> button until <b>AUTO</b> is displayed. Incorrect note detection may also occur occasionally with any instrument if the signal is weak or indirect, especially when using the built-in mic. Also, certain instruments—especially bar and reed-based ones like harmonica or accordion—have very strong overtones making note detection very difficult. In any case, using an external mic or pick-up (like the Peterson TP-1) can improve detection. Settings under <b>KEY</b> and the <b>A4</b> reference menu items can also (correctly) cause the displayed note to be offset from the expected one.
In Line-Out Audio mode, I cannot get a tone signal to my PA	A 1/4" plug may still be inserted in the <b>THRU</b> jack. This cuts off the tone signal, which normally would exit the <b>IN/OUT</b> jack.
The display screen appears but then fades away	Batteries are old or discharged.

## TECHNICAL SPECIFICATIONS

<b>WEIGHT</b>	1.2lbs (544g)
<b>SIZE</b>	7.5"(19cm) x 4.3"(11cm) x 2.3"(6cm) HxWxD
<b>POWER</b>	180mA @2.0V to 80mA @4.6V; 3-AA batteries or regulated power adapter: 2.1mm(+) / 5.5mm(-)
<b>ACCURACY</b>	0.001 semitone (0.1 cents or to within $\pm 0.0029\%$ ) internal <i>and visually observable!</i>
<b>INPUT</b>	Internal condenser microphone $\pm 10\text{mV}$ to 5V on 1/4" phone jack
<b>OUTPUT</b>	1/4" jack (mono) 10k $\Omega$ minimum external impedance
<b>tone Signal Output Range</b>	Normal: 16Hz ( $\sim C_0$ ) to 8133Hz ( $\sim B_8$ ) Bass Shift: 4Hz ( $\sim C_{.2}$ ) to 2033Hz ( $\sim B_6$ )
<b>Strobe Range</b>	Normal: 32Hz ( $\sim C_{.1}$ ) to 6272Hz ( $\sim G_8$ ) Bass Shift: 8Hz ( $\sim C_{.1}$ ) to 1975Hz ( $\sim B_6$ )
<b>OPTIONAL ACCESSORIES</b>	Carrying Case Mic-stand tuner-support system TP-1 clip-on pick-up Dynamic handheld microphone

## WARRANTY

We warrant this product to be free of defects in materials or workmanship for a period of ONE year after delivery to the original purchaser. Our obligation under this warranty is limited to the replacement or repair of any part or parts which prove upon our examination to be defective.

This warranty does not apply to damage resulting from transportation, misuse, abuse, or alteration. The complete unit must be returned to our factory, transportation charges prepaid. In order to speed the return of the unit to you, it is recommended that for all repairs, other than those required as a result of shipping damage, you deal directly with our factory. In case of damage in shipment, a claim should be filed with the carrier. Be sure to include a brief description of the difficulty you are experiencing and your return address.

The above warranty is contingent upon the accompanying registration card being filled in and returned to the factory within 10 days of the date of receipt of the product by the original purchaser. The warranty conveys specific legal rights to the purchaser; other rights vary from state to state and internationally.

Written/revised by Mike Skubic and John Norris  
© 2003 Peterson Electro-Musical Products, Inc. All Rights Reserved.